

# MANISCOPIC

# MHT 10160 L

Turbo

- Capacity : 16000 kg
- Lift height : 9.70 m
- Maximum forward reach : 5.50 m
- Engine : 175 HP
- 4 wheel steer – 4 wheel drive
- Hydrostatic transmission
- Frame levelling 10°/10°



 **MANITOU**

# MHT 10160 L TURBO

## LOAD CENTRE AT 600 MM

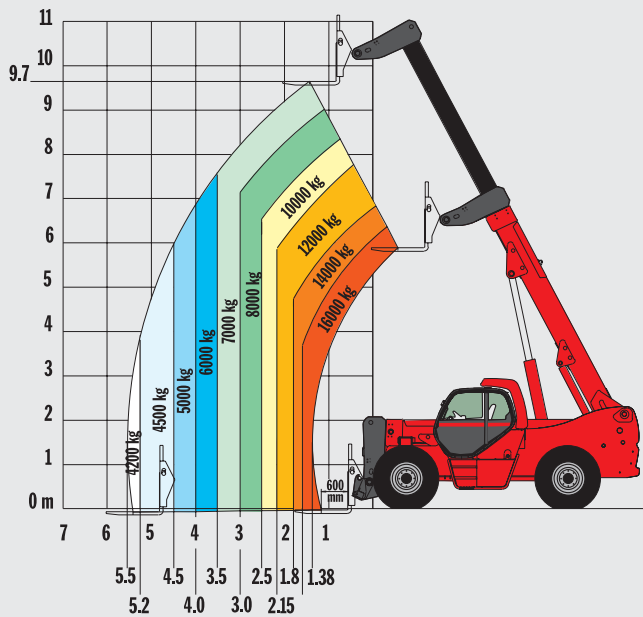

## LOAD CENTRE AT 1200 MM

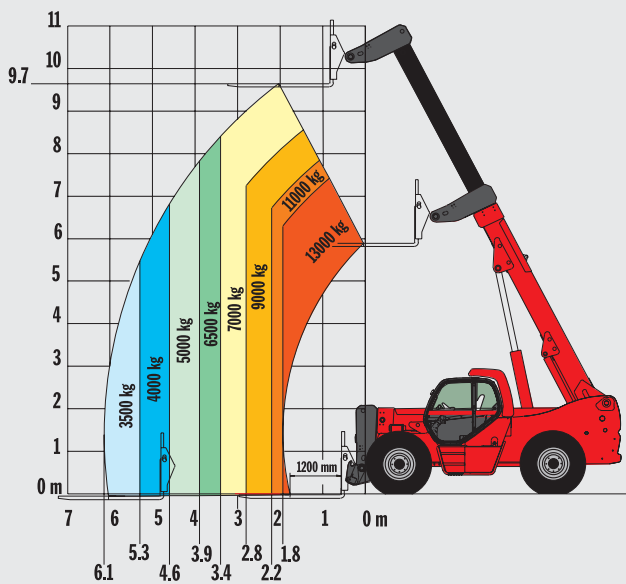

## ENGINE

Diesel MERCEDES OM 904 LA Turbo – Intercooler – Air / Air

Capacity : 4 cylinders / 4250 cm3  
 Power (ISO/TR 14396) : 175 HP / 129 kw  
 Rated speed : 2200 r.p.m.  
 Maximum torque at 1200 r.p.m. : 675 Nm

Electronic injection (4 injection pumps and 4 injectors)

Fan : puller  
 Cooling : water

Anti-polluting standards  
 Air filter (type / micron) : cartridge / 3  
 Battery : 12 Volts  
 Capacity : 120 Ah

## LIFT CAPACITY / HEIGHT

Load centre	at 600 mm	at 1200 mm
Lift capacity :	16000 kg	13000 kg
Capacity at max. height	7000 kg	7000 kg
Capacity at max. front reach :	4200 kg	3500 kg
Lift height :	9.70 m	9.70 m
Maximum front reach :	5.50 m	6.10 m

## TRANSMISSION

Hydrostatic transmission **REXROTH**

Hydrostatic variable flow pump : 125 cm3  
 Hydrostatic variable cylinder engine : 160 cm3  
 Reversing shift : electro-magnetic  
 Differential central : YES

2 forward and reverse speeds :

Low speed : 10 km/h  
 Fast speed : 25 km/h

## HYDRAULICS

**Main pump :** Piston Load Sensing REXROTH Haute pression

Capacity : 75 cm3  
 Maximum pressure : 350 bar  
 Flow : 170 L/mn  
 Max. flow on attachment (at 280 bar) : 120 L/mn

**Steering pump :**

Type : Load sensing  
 Maximum pressure : 210 bar

**Power brake circuit pump :**

Type : **REXROTH**  
 Capacity : 25.7 cm3  
 Maximum pressure : 40 bar  
 Flow : 59 L/mn

**Hydraulic oil radiator :**

2 continuous fans  
 2 automatic fans

**Distributor :** Big flow hydraulic proportional REXROTH (280 to 300 L/mn) with 4 closed centre elements

**Drive Type :**

Electro-Proportional hydraulic joystick with 3 movement combination

- 1- Lifting / Crowding
- 2- Boom extension / Attachment
- 3- Lifting / Boom extension

**Flexibles :**

TP tube type with high pressure type flexible links

**Filtration degree (micron) :**

Suction : 250 mic  
 Return : 10 mic  
 Filtration air tank : 10 mic

## DIAGRAMS

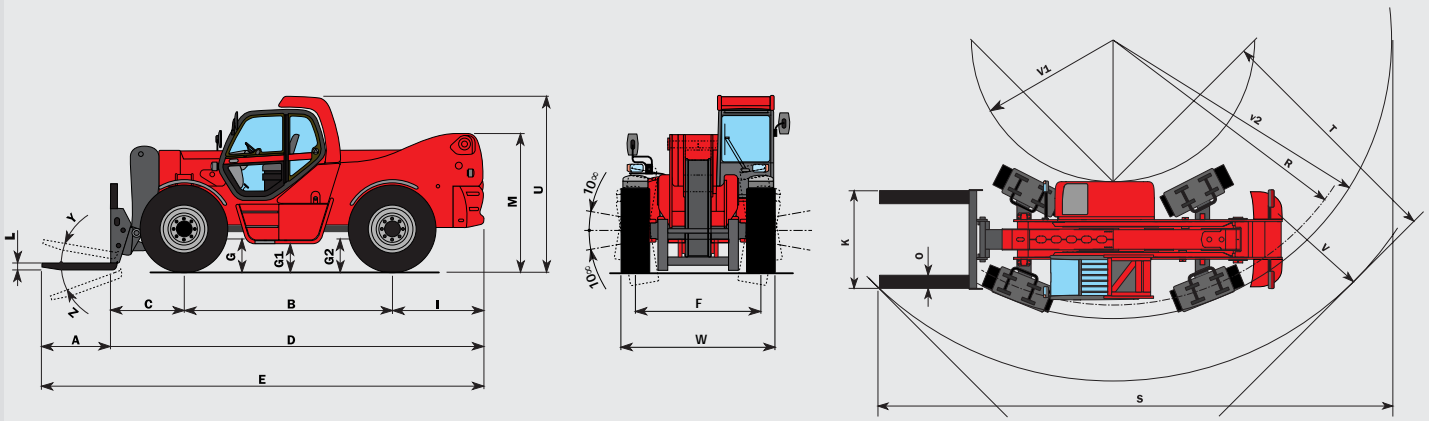

A	B	C	D	E	F	G	G1	G2	I	K	L	M	O	R	S	T	U	V	V1	V2	W	Y	Z
1500	3650	1335	6605	8105	2000	685	445	685	1620	1750	80	2300	200	5445	10345	4255	2935	6810	2870	5685	2500	12°	105°

### AXLES

OMCI (stacker) Heavy Duty type, oil bath with epicycloidal reduction with 3 satellites Integrated steering cylinders with double action in high position

Frame levelling 10°/10° on front axle

3 steering modes:

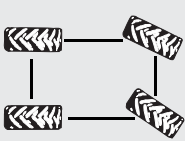

2 WHEEL STEERING

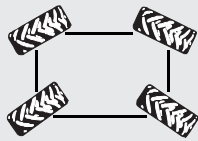

4 WHEEL STEERING

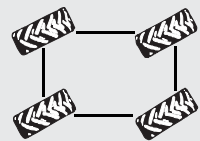

CRABSTEER

### BRAKES

Type : oil bath multidisc  
 Drive type : hydraulic  
 On axle : front + rear

Parking brake on front and rear axles :  
 Oil bath multidisc negative parking brake

### TYRES

Model : 16.00 R 25  
 Pressure : 9 bar  
 Drawbar pull : 15500 daN

### LIFTING/TELESCOPING MOTIONS

Unladen lifting : 25 sec  
 Unladen lowering : 17 sec

Unladen extending internal telescope : 14 sec  
 Unladen retracting internal telescope : 11 sec

### FORKS

Standard equipment TFF MT 1750  
 Dimensions : 200 x 80 x 1500 mm  
 Weight of forks : 560 kg

### CAPACITIES

Cooling circuit : 16 L  
 Engine oil : 15.8 L  
 Equipment hydraulic oil : 290 L  
 Fuel tank : 200 L

### WEIGHT

Total weight without equipment : 22300 kg  
 Total weight unladen with forks : 23615 kg  
 Total weight laden with forks : 39615 kg

#### Load on axle with standard equipment (unladen)

On front axle, boom retracted : 9430 kg  
 On rear axle, boom retracted : 14185 kg

#### Load on axle with standard equipment (laden)

On front axle, boom retracted : 34200 kg  
 On rear axle, boom retracted : 5415 kg

### STANDARD EQUIPMENTS

- ROPS-FOPS cabin
- GRAMMER seat
- Front and rear wipers
- Driving lights
- Rotating beacon
- Left rearview mirror
- Safety device with automatic lock of aggravating movements
- Safety valves on cylinders
- Heating
- TFF

### OPTIONS

- Air conditioning
- Comfort seat
- Roof wipers
- Cabin rearview mirror

Equipment customised on order



# Manitou, material handling world leader

Inventor of the rough terrain forklift truck, Manitou offers today the most comprehensive range to meet all specific handling and personal lifting requirements :

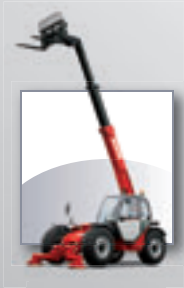

**MANISCOPIC**  
Telescopic trucks



**MANITOU**  
Rough terrain and semi industrial masted trucks



**MANIACCESS**  
Access equipment



**Twisco**  
Compact telescopic handler



**MANIHOE**  
Backhoe/Loader with telescopic boom



**MANITRANSIT**  
Truck mounted forklifts



**MANILOADER**  
Articulated wheeled loaders



**MANILEC**  
Electric pallet trucks and electric stackers

## A network of skilled professionals at your service !

With a network of 600 service and parts centres in more than 120 countries, Manitou provides an efficient after-sales support based on the expertise of thousands of factory trained technicians.



The equipment supplied with each model may differ from that described in this leaflet. For more details, contact your MANITOU dealer.