



# GEHL Skid Steer Loaders

One of the broadest model ranges in the world.

Compact • powerful • versatile • easy to service • reliable

For over 35 years GEHL has proven its position as a leading manufacturer of skid steer loaders.

With engine performance between 23,9 and 99 HP and 8 different model sizes GEHL offers a complete range of skid steer loaders. When it comes to heavy-duty applications the SL 7810E with true vertical lift is the solution offering you more power and unmatched hydraulic flow. Besides the extraordinary performance, all GEHL machines are very service and maintenance friendly. The choice of different control systems also meets the demand and preference of every operator.

The innovative design of the POWER-VIEW™ boom not only provides an excellent overall view for the driver, the optimized structure also allows for high breakout forces.



## Comfortable Working Station

Some advantages on the new GEHL skid steer loaders are quite obvious. There is the spacious entrance into the cabin with extra handles at the outer cabin frame for added convenience. Ample floor space also caters to tall machine operators. The large covered openings in the cabin roof offers added visibility with the loading boom in the fully raised position. The rear window is large and it serves as an emergency exit. An optional door for the cabin with sliding windows creates a comfortable atmosphere, free of dust and independent of the weather. In addition, the interior cabin sound levels are below the CE requirements. This increases the operator's comfort inside the working station, plus the fully adjustable suspension seat, and comfortable hand controls.

## Safety Improvements

GEHL Skid Steer loaders are equipped with head lights, tail lights and rear lights to facilitate their use at other than daylight hours and under poor visual conditions. An optional weather enclosure door with a sensor system to lock out lift arm and tilt cylinder functions when door is open prevents from damages through inadvertent movement of the lift arm (from SL 3840E upwards). Hydraulic self-leveling lift action is an additional feature available for all GEHL Skid Steer Loaders (from SL 3840E upwards).

At the same time, a hydraulic locking device (HYDRALOC™) prevents any inadvertent lowering of the lifting boom bucket or moving of the machine (from SL 3840E upwards). In addition the loaders are fitted with a mechanical boom locking device to ensure a safe maintenance working environment. A longer wheelbase provides for higher stability and higher lift capacities especially in uneven working areas.



## NEW - SL 1640E

The brandnew SL 1640E is the smallest loader in GEHL's Skid Steer Loader line.

Besides a working width between 0.9 m and 1.1 m, this compact loader is also low in operating weight. Therefore, it's easy to transport and is ideal for small openings where bigger machines can not access. It can move through narrow doorways, aisles and gates, as well as work under low ceilings.

The 1640E is a multiple attachment carrier that doesn't just move dirt and manure. GEHL's engineers have really beefed up this loader's performance by adding the hydraulic components used in the SL 3840E, giving it the ability to effectively operate different types of attachments.

Naturally, this model is also featuring the universal ALL-TACH™-mounting plate. In addition, the breakout force and operating capacity are unmatched in this loader size class. Additional standard features are a hand and foot throttle control enabling the operator to efficiently adjust the throttle and minimize fuel consumption.

This small loader provides all the comfort expected from larger models: Excellent overall view due to the Power View Boom™ design, a smooth ride provided by an extended wheelbase, comfortable and less fatigue controls, supported arm rests, adjustable rolling seat belt, very low noise emissions and vibrations in the operator's compartment, a lockable fuel tank and a battery disconnect switch.



# SL 3840E

## Powerful Yanmar Engine

The SL 3840E is powered by a 3-Cylinder Yanmar Diesel engine with a power output of 35 HP at 2.600 rpm. As GEHL is constantly working to improve, enhance and increase performance, versatility, efficiency and operator comfort this new model grants users the edge in productivity and profitability.



## Superior features

The SL 3840E features operating load ratings of 476 kg.

The compact low-profile design combined with the reversible rims allows for manoeuvrability in narrow as well as in low-clearance areas.

With a shipping weight below 1.6 tons, the SL 3840E ensures easy transport even on a small trailer.



## Low noise emissions

Due to the acoustical improvements and the new designed engine-related components the sound level has been reduced dramatically to become one of the lowest sound emissions in the industry.

## Operator`s comfort

T-bar drive controls require less effort and reduce operator`s fatigue.

An adjustable safety bar makes the GEHL loader a comfortable working station for everyone.

Sliding windows are standard on this model.



# SL 4240E / SL 4640E / SL 5240E / SL 5640E / SL 6640E

## Turbo Power / High Speed Driving Performance

The latest development of liquid-cooled, direct injected Diesel engines feature a power output between 46 HP and 82 HP. This new generation of engines offers an automatic engine shutdown system to prevent engine damage from high oil temperature or low oil pressure. Furthermore, the low fuel consumption is unmatched.

Starting with the SL 4640E, a two-speed drive option is available, which enables for a maximum top speed of 18,0 km/h.

The button for this two speed drive gear is integrated in the left hand drive control of the new control handles. With the help of the "Soft-Shift-System" down-shifting from high to low speed is made smooth and easy.



## Genuine GEHL Controls: T-bar Controls

The traditional GEHL T-Bar Controls have been enhanced with the new-style, ergonomic handles on the drive controls. This genuine GEHL control system supports for fatigue free working conditions through low effort control handles.



## T-bar/Joystick Controls

Starting with the SL 4640E GEHL offers for the first time the all new T-Bar/Joystick controls. This is a new alternative control option that gives an operator the full single hand T-bar control for all drive movements and single joystick control for lift and tilt functions of the loader.

GeHL engineering has combined the proven advantages of its unique T-bar drive control along with a modern Joystick for easy loading operations. Operators confirm: This combination is the best of both worlds.

## GEHL Hydraglide™

A feature recommended for the 2-speed option is the unique GEHL Hydraglide™ system, which provides for enhanced driving comfort. On this option a nitrogen accumulator in the cylinders dampens oscillations in the lifting booms. Any impact between chassis and lifting boom are dampened which prevents possible build-up of such oscillations. Hydraglide comes as a standard on all T-bar / Joystick models.



## Air Conditioning

Starting with SL 5240E, an ex works installed air condition system is available as an option. The A/C system has been designed to fit the engine hood cover to make sure overall dimensions of the loaders stay as compact as possible.

## Superior Performance and Reliability

Besides all mentioned advantages the GEHL 40 series come with some extraordinary technical details:

- ✓ The drivetrain on the models SL 4240E / SL 4640E / SL 5240E / SL 5640E / SL 6640E feature heavy-duty drive components.
- ✓ Super power drive chains feature heavy, high strength construction, designed to stand up to rugged conditions.
- ✓ Adjustments can be made to the simple "bow tie" chain system from outside the unit.
- ✓ The forged one-piece axle shafts feature heavy-duty tapered roller bearings and "quad" lip seals with trash protection built-in around the seal area.



# Designed for Service Efficiency

The arrangement of the individual components facilitates easy service and maintenance work. This general feature plus the tiltable operator's cabin provide quick access to these components for daily inspection and service. Removeable bottom access plates ensure an easy clean out.



## Unique: GEHL-T-Bar-Control



### Your advantages:

- Easy to learn / Easy to use
- No complicated hand and foot combinations
- T-bar enables for precise drive control especially in difficult ground conditions

## Unique: GEHL-T-Bar/Joystick-Control

The right hand T-bar or Joystick is for all lifting actions

- 1 By moving the T-bar or Joystick forward or pulling it backward the lift arm moves in the same direction
- 2 Turning the T-bar or Joystick to the right or left tilts the bucket for loading or dumping



optional

The left hand T-bar controls all drive actions

- 3 Moving the T-bar forward or pulling it backward drives the machine forward or backward
- 4 Turning the T-bar to the right or left steers the loader in the required direction

# Optional Control Systems

## Dual Joystick Controls

The dual joystick controls provide operators with virtually everything "at their fingertips" for precise operation. Using it in conjunction with the standard foot throttle makes operating the loader more efficient - the foot pedal allows to run the engine at a slower speed to save fuel, reduce speed and noise and it allows to increase engine speed when more power or speed is required.



## Hand/Foot controls

This control option features new angle handle controls to include a rocker switch on the right handle for activating the aux. hydr. control. The handles control all loader movements. The foot pedals control all lift arm and bucket movements.



## Power A-Tach™

In addition to the well-established GEHL ALL-TACH™ mounting plate which is compatible with most allied attachments on the market, the 40 series has an optional switch on the left control panel which allows the electric controlled locking of the attachment to be engaged or disengaged without even leaving the seat.

# SL 7810E



For big jobs, you want a big machine with more power, more strength, more speed. In a word, more muscle. With the new GEHL skid loader SL 7810E, you get all the muscle you'll ever need with a SAE rated operating load of 1.805 kg and lifting height of 3,6 m. The GEHL philosophy has been to up-grade skid-steer loaders to become an economic alternative to the articulated loaders. Following this strategy the cabin is one of several items which have been improved to provide maximum comfort – including optional air-conditioning.

The long wheelbase of nearly 1.4 m and the perfectly balanced load distribution provide for safe manoeuvring. The optional ride control HYDRAGLIDE™ provides an even smoother ride. This size of loader is used mainly in ship-trimming, at road construction sites, recycling plants and at maintenance facilities. This is the leader where high-performance attachments are suggested. The SL 7810E's hydraulic system delivers up to 155 l/min. to support a vast variety of attachments.

The GEHL Power-A-Tach™ is a great feature to drivers who need to change from one attachment to another at a snap just by pressing only one control button.



GEHL All-Tach™ system is compatible with most skid loader attachments and makes connecting as well as disconnecting fast and easy.



Drip-free, flat-faced auxiliary hydraulic couplers are well protected and conveniently located.

Optional high-flow auxiliary hydraulic system delivers up to 155 l/min to support high-performance attachments.

# Unmatched:

LIFT HEIGHT: 4.770 mm

HEIGHT TO HINGE PIN: 3.607 mm

DUMP HEIGHT: 2.718 mm

CUMMINS 99 HP TURBO DIESEL ENGINE

GROUND SPEED UP TO 20 km/h



The engine cover features gas-spring assist for easy opening. Removable side panels provide quick access to service points and filters. A build-in hydraulic pump lifts the entire ROPS/FOPS structure up and out of the way for complete access to traction drive and hydraulic components. An optional electric pump is also available for ROPS lift.



## Vertical Lift

The true vertical-lift linkage gives you total control and provides consistent forward reach through-out the entire lift cycle.

And with GEHL's hydraulic self-leveling lift action, the load always stays level as the boom rises.

GEHL SL 7810E – greater reach and control.









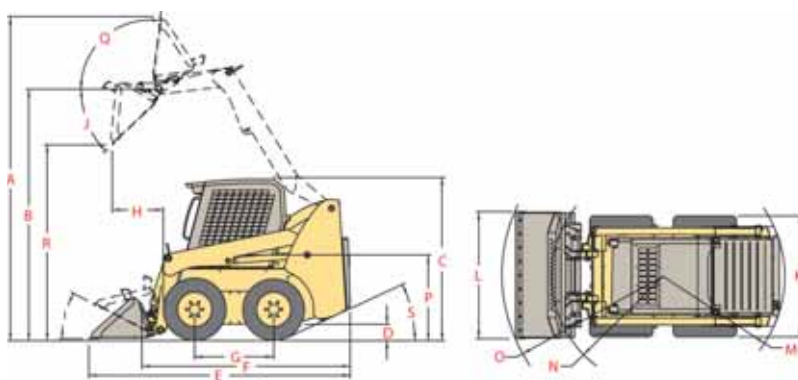





A new swing-open rear door, swing-up engine cover, and swing-out cooling package provide quick and complete access to the engine compartment.







MEASUREMENTS		SL 1640E	SL 3840E	SL 4240E Deluxe
A.	Overall operation height-fully raised	3.167 mm	3.546 mm	3.584 mm
B.	Height of hinge pin-fully raised	2.438 mm	2.746 mm	2.794 mm
C.	Overall height	1.897 mm	1.786 mm	1.826 mm
D.	Ground Clearance (between wheels)	150 mm	152 mm	211 mm
E.	Overall length (with bucket)	2.576 mm	2.896 mm	2.952 mm
F.	Overall length (less bucket)	1.905 mm	2.258 mm	2.314 mm
G.	Wheel base	775 mm	876 mm	932 mm
H.	Dump reach	410 mm	579 mm	574 mm
I.	Rollback at ground	23,4°	29°	29°
J.	Dump angle	76°	42°	42°
K.	Overall width (tires standard)	5,7x12=909 mm	27x8.5x15=1.229 mm**	10.00x16,5=1.483 mm**
L.	Bucket width – standard	915 mm	1.380 mm	1.520 mm
M.	Clearance circle-rear	1.097 mm	1.374 mm	1.484 mm
N.	Clearance circle-front (less bucket)	833 mm	1.120 mm	1.102 mm
O.	Clearance circle-front (with bucket)	1.473 mm	1.763 mm	1.758 mm
P.	Seat to ground height	879 mm	828 mm	853 mm
Q.	Rollback at full height	60,8°	99°	99°
R.	Dump height	1.836 mm	2.146 mm	2.197 mm
S.	Departure angle	30°	26°	29°
SPECIFICATIONS		SL 1640E	SL 3840E	SL 4240E Deluxe
	Operating weight	1.352 kg	1.814 kg	2.096 kg
	Tip capacity	775 kg	952 kg/1.066 kg***	1.338 kg
	Operating capacity	387 kg	476 kg/533 kg***	669 kg
	Breakout force	803 kg	1.270 kg	1.270 kg
HYDRAULICS				
	Loader circuit pump	38,2 l/min	52 l/min	58 l/min
	Loader circuit pressure	155 bar	190 bar	190 bar
	Hydraulic reservoir	27 l	38 l	38 l
	MAX. TRAVEL SPEED	0 - 8,9 km/h	0 - 10,3 km/h	0 - 13,2 km/h
	2-Speed -optional-			
STANDARD BUCKETS ( WIDTH / VOLUME)				
	Standard bucket	915 mm / 0,12 m	1.380 mm / 0,28 m	1.520 mm / 0,31 m
	Utility bucket	915 mm / 0,18 m	1.380 mm / 0,35 m	1.520 mm / 0,40 m
	Lightmaterial bucket	915 mm / 0,25 m	1.380 mm / 0,43 m	1.520 mm / 0,48 m
BACKHOE ATTACHMENT				
	A. Loading height	1.600 mm	2.000 mm	2.000 mm
	B. Reach from pivot	2.500 mm	2.830 mm	2.830 mm
	C. Digging depth	1.800 mm	2.200 mm	2.200 mm
ENGINE				
	Manufacturer	YANMAR	YANMAR	YANMAR
	Diesel	3TNV82BPMS	3TNV88	4TNV88
	Power output max.	23,9 HP / 17,8 kW	35 HP / 26,1 kW	46 HP / 34 kW
	at rpm	2.400 rpm	2.600 rpm	2.600 rpm
	Cylinder/displacement	3 / 1.330 cm	3/1.640 cm	4/2.190 cm
	Fuel capacity	29 l	38,9 l	47 l

TIRES -OPTIONAL-	SL 1640E	SL 3840E	SL 4240E	SL 4640E	SL 5240E	SL 5640E	SL 6640E	SL 7810E
Overall width (w/ 23-8,5x12 tires)	1.052 mm							
Overall width (w/10.00x16,5 tires)					1.570 mm			
Overall width (w/ 10.50x15 tires)		1.321 mm	1.321 mm					
Overall width (w/ 12.00x16,5 tires)				1.651 mm	1.651 mm	1.702 mm	1.702 mm	
Overall width (w/ 7.00x15 tires)		1.207 mm						
Overall width (w/ 14.00x17,5 tires)						1.816 mm	1.816 mm	2.057 mm
Overall width (w/ 33-15,50x16,5 tires)				1.842 mm	1.842 mm	1.842 mm	1.842 mm	

SL 4640E	SL 5240E	SL 5640E	SL 6640E	SL 7810E
3.785 mm	3.950 mm	4.115 mm	4.275 mm	4.770 mm
2.934 mm	3.104 mm	3.124 mm	3.157 mm	3.607 mm
1.981 mm	2.019 mm	2.057 mm	2.083 mm	2.057 mm
191 mm	229 mm	203 mm	231 mm	231 mm
3.119 mm	3.208 mm	3.327 mm	3.594 mm	4.089 mm
2.281 mm	2.370 mm	2.426 mm	2.565 mm	3.099 mm
953 mm	1.054 mm	1.080 mm	1.229 mm	1.397 mm
701 mm	701 mm	833 mm	871 mm	970 mm
27°	27°	30°	30°	28,5°
42°	40°	40°	40°	38°
10.00x16,5=1.575 mm	12.00x16,5=1.651 mm	12.00x16,5=1.702 mm	14.00x17,5=1.841 mm	14.00x17,5=2.057 mm
1.680 mm	1.760 mm	1.760 mm	1.830 mm	2.140 mm
1.513 mm	1.562 mm	1.679 mm	1.753 mm	2.045 mm
1.194 mm	1.219 mm	1.283 mm	1.372 mm	1.539 mm
1.892 mm	1.930 mm	2.083 mm	2.299 mm	2.583 mm
953 mm	991 mm	1.067 mm	1.100 mm	1.041 mm
96°	96°	84°	84°	85°
2.273 mm	2.139 mm	2.375 mm	2.408 mm	2.718 mm
23°	26°	26°	29°	21°
SL 4640E	SL 5240E	SL 5640E	SL 6640E	SL 7810E
2.914 kg	2.939 kg	3.348 kg	3.538 kg	4.772 kg
1.496 kg/1.632 kg***	1.724 kg/1.860 kg***	1.996 kg/2.268 kg***	2.358 kg/2.630 kg***	3.610 kg
748 kg/816 kg***	862 kg/930 kg***	998 kg/1.134 kg***	1.179 kg/1.315 kg***	1.805 kg
2.064 kg	2.064 kg	2.676 kg	2.676 kg	3.783 kg
72/114* l/min	72/114* l/min	87/136* l/min	87/136* l/min	110/155* l/min
190/172* bar	190/172* bar	206/200* bar	206/200* bar	228/228* bar
45 l	45 l	61 l	61 l	57 l
0 - 12 km/h	0 - 12 km/h	0 - 13,0 km/h	0 - 13,0 km/h	0 - 12 km/h
0 - 19 km/h	0 - 19 km/h	0 - 19,8 km/h	0 - 19,8 km/h	0 - 20 km/h
1.680 mm / 0,37 m	1.760 mm / 0,43 m	1.760 mm / 0,43 m	1.830 mm / 0,45 m	2.140 mm / 0,89 m
1.680 mm / 0,57 m	1.760 mm / 0,59 m	1.760 mm / 0,59 m	1.830 mm / 0,62m	2.140 mm / 1,06 m
1.680 mm / 0,57 m	1.760 mm / 0,62 m	1.760 mm / 0,62 m	1.830 mm / 0,65 m	2.140 mm / 1,29 m
2.350 mm	2.350 mm	2.350 mm	2.450 mm	2.450 mm
3.350 mm	3.350 mm	3.350 mm	3.900 mm	3.900 mm
2.600 mm	2.600 mm	2.600 mm	3.050 mm	3.050 mm
DEUTZ	DEUTZ	YANMAR	YANMAR	CUMMINS
TD2009L4	TD2009L4	4TNV98T	4TNV98T	B4.5T-99C
63 HP / 47,2 kW	63 HP / 47,2 kW	82 HP / 61 kW	82 HP / 61 kW	99 HP / 74 kW
2.500 rpm	2.500 rpm	2.500 rpm	2.500 rpm	2.200 rpm
4/2.300 cm	4/2.300 cm	4/3.100 cm	4/3.100 cm	4/4.500 cm
57 l	57 l	72 l	91 l	115,4 l

\*\*\*reversible rims: 1.517 mm

Remarks: GEHL reserves the right to make changes in specifications shown herein or add improvements at any time without notice or obligation.

# The Highlights

HIGH EFFICIENCY ENGINES with low fuel consumption

2-SPEED option from SL 4640E upwards  
with SOFT-SHIFT SYSTEM

POWER-VIEW™-BOOM allows unmatched operator  
visibility while providing extra lifting strength

ENLARGED OPERATOR STATION offers more seating adjust-  
ments, a suspension seat, more comfort and  
unmatched front, overhead and side visibility

Exclusive HYDRAGLIDE-SYSTEM™ (optional)

HYDRAULIC SELF-LEVELING LIFT ACTION (4240E upwards)

EASY TO SERVICE due to the optimum component access

Concealed load arm HYDRAULIC TUBES  
are protected by the boom

Liquid-COOLED DIRECT INJECTION ENGINES with  
engine auto-shutdown to prevent damages through high  
temperatures or low oil pressure

INTERNAL SERVO CONTROLLED (POWER STEERING)  
High gain controllers for excellent response and control  
(4640E upwards)

ZERO MAINTENANCE AXLES lubricated and sealed for life,  
requiring no routine lubrication

MAINTENANCE-FREE DRIVE COUPLING with  
clamp-style hub to the hydrostatic piston pump

HYDRALOC™-BRAKE-SYSTEM locks lift, tilt and drive systems  
when operator leaves the seat, raises the restraint bar, or  
turns off the ignition switch. Brakes are oil immersed multiple  
discs that require no maintenance

NITRO-STEEL™ hardened cylinder rods. Innovative  
hardening process produces a harder rod that is more  
resistant to damaging and corrosion



## Featured Equipment

	1640E	3840E	4240E	4640E	5240E	5640E	6640E	7810E
Auxiliary Hydraulics	STD	STD	STD	STD	STD	STD	STD	STD
Brake Control (auto/manual)	STD	STD	STD	STD	STD	STD	STD	STD
Engine Heater	OPT.	OPT.	OPT.	OPT.	OPT.	OPT.	OPT.	OPT.
Foot & Hand Throttles	STD	STD	STD	STD	STD	STD	STD	STD
Anti-Vandalism Protection	STD	STD	STD	STD	STD	STD	STD	STD
Full Instrumentation	STD	STD	STD	STD	STD	STD	STD	STD
T-Bar/Joystick Controls	NA	NA	NA	OPT.	OPT.	OPT.	OPT.	NA <sup>(D)</sup>
Hand/Foot Controls (C)	NA	OPT.	OPT.	OPT.	OPT.	OPT.	OPT.	OPT.
Remote engine oil filter	NA	NA	NA	STD	STD	STD	STD	OPT.
Hourmeter	STD	STD	STD	STD	STD	STD	STD	STD
Hydraloc™-System	NA	STD	STD	STD	STD	STD	STD	STD
Hydrostatic Drive	STD	STD	STD	STD	STD	STD	STD	STD
Independent Hydr. Reservoir	STD	STD	STD	STD	STD	STD	STD	STD
Integral Access Plate (removable)	STD	STD	STD	STD	STD	STD	STD	STD
Lift Arm Support Device	STD	STD	STD	STD	STD	STD	STD	STD
Operational Lights - frt & rear	STD	STD	STD	STD	STD	STD	STD	STD
Operator Restraint Bar with padded Armrests/Seat Belt	STD	STD	STD	STD	STD	STD	STD	STD
Suspension Seat	STD	OPT.	STD <sup>(A)</sup>	STD	STD	STD	STD	STD
Engine Auto-Shutdown System	NA	OPT.	STD <sup>(A)</sup>	STD	STD	STD	STD	STD
All-Tach™ Attachment Mounting	STD	STD	STD	STD	STD	STD	STD	STD
Overhead Guard (with integral side screens)	NA	STD	STD	STD	STD	STD	STD	STD
Self-Leveling Lift Action	OPT.	OPT.	STD	STD	STD	STD	STD	STD
Sound Reduction Package including Sliding Side Windows	STD <sup>(B)</sup>	STD	STD <sup>(A)</sup>	STD	STD	STD	STD	STD
Spark Arrestor Muffler	STD	STD	STD	STD	STD	STD	STD	STD
Battery Disconnect Switch	STD	STD	STD	STD	STD	STD	STD	STD

(A) OPT. on rental version

(B) Not sliding on SL 1640E

(C) No foot throttle available

(D) Full Joystick Controls OPT.



## Attachments

GEHL's full range of attachments supports time saving and reduced labor costs. The ALL-TACH™-mounting plate allows for quick and easy mounting and dismantling of the individual attachments. The models are suitable for nearly all of the attachments on the market, including products from other manufacturers.

GEHL Europe GmbH  
PO BOX 12 54  
48485 Neuenkirchen  
Germany

Tel: +49 5973 63 302  
Fax: +49 5973 63 303  
[www.gehl.de](http://www.gehl.de)  
[info@gehl.de](mailto:info@gehl.de)

Your responsible dealer:



GEHL's Madison, South Dakota, USA,  
manufacturing plant features an ISO 9001  
registered quality management system.



# Skid Steer Loaders

# GEHL

SL 1640E

SL 3840E / SL 4240E



SL 4640E / SL 5240E

SL 5640E / SL 6640E

SL 7810E